

OUTLINE DIMENSIONAL DRAWING

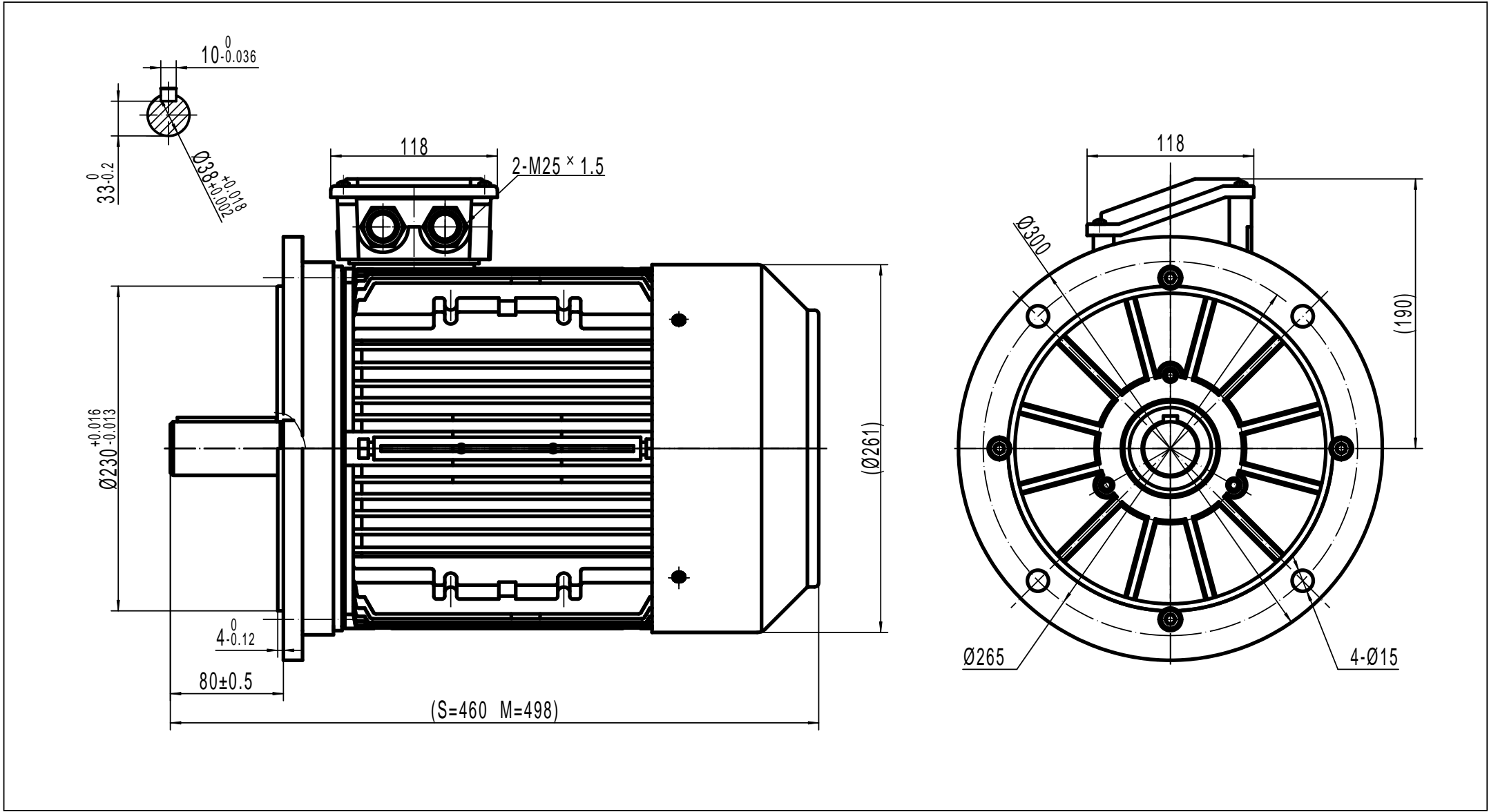

TECHTOP AUSTRALIA PTY LTD	
FRAME	TAI 132A B5
DATE	DRAWING NO.
2011/10/14	1ST087.055.001-024 A